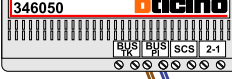

— = systeemkabel
Bij kabel 2 x 1 mm²:
180% afstand!
Bij kabel 2 x 0,28 mm²:
60% afstand!
UTP op aanvraag.

Digitizers & flatcables

Niet monteren/demonteren
onder spanning
Bedrukkers mogen wel

346050 bticino
BUS | BUS | SCS | 2-1

De twee stijgers
echt OP de klemmen
van E-67 aansluiten!

TWEEDRAADS BUS

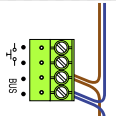

Bij monteren/demonteren
spanning eraf
voorkomt defecten!

M-50



De aders moeten
echt OP de connector
doorgelust worden!



nelec

INTERCOM MADE EASY

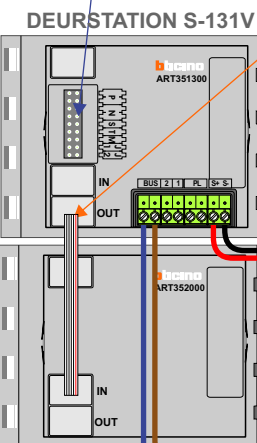
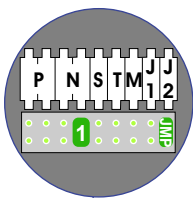
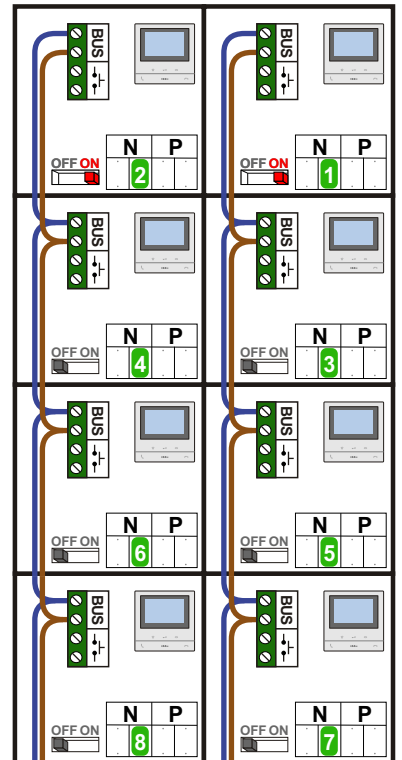

Haal de spanning van het
systeem als je een module
monteert of demonteert

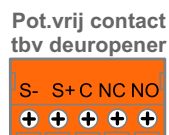

Max. 100 meter system-
kabel tot laatste videofoon

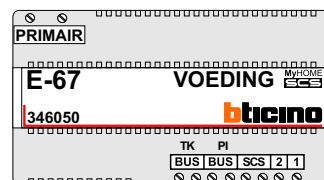

Max. 50 meter

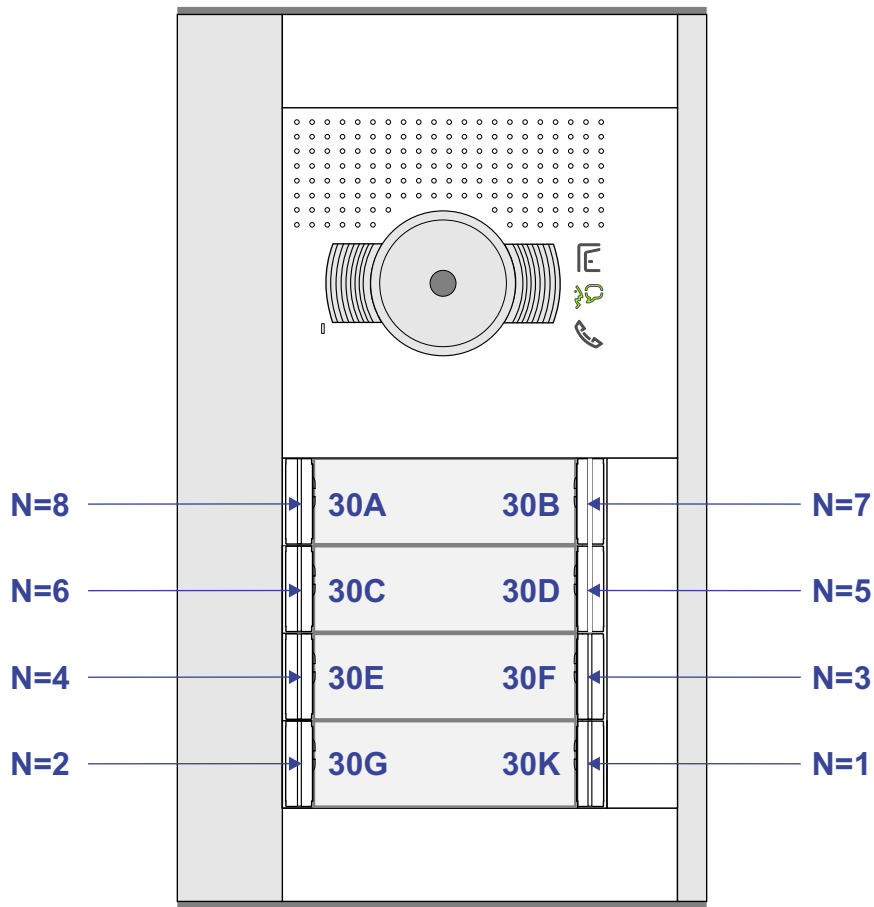

nelec

INTERCOM MADE EASY

N-Waarde	Huisnummer	Switch-ON
1	30K	X
2	30G	X
3	30F	
4	30E	
5	30D	
6	30C	
7	30B	
8	30A	