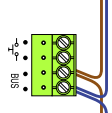
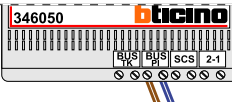

— = systeemkabel
 Bij andere getwiste kabel 66% afstand!
 Bij ongetwiste kabel max. 50 meter buitenpost naar videofoon.
 UTP op aanvraag.

Digitizers & flatcables

 Niet monteren/demonteren onder spanning
 Belrukkers mogen wel

M-50

 De aders moeten echt OP de connector doorgelust worden!

346050 bticino

 De twee stijgers echt OP de klemmen van E-67 aansluiten!

TWEEDRAADS BUS

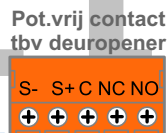
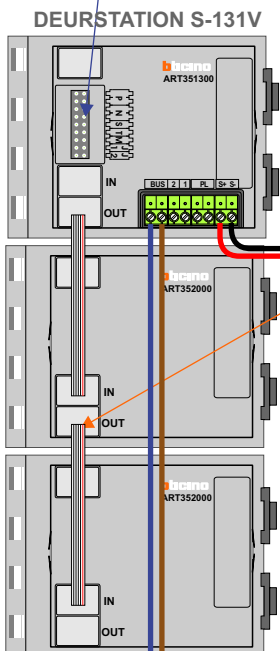
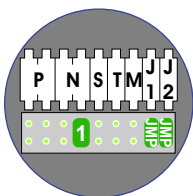
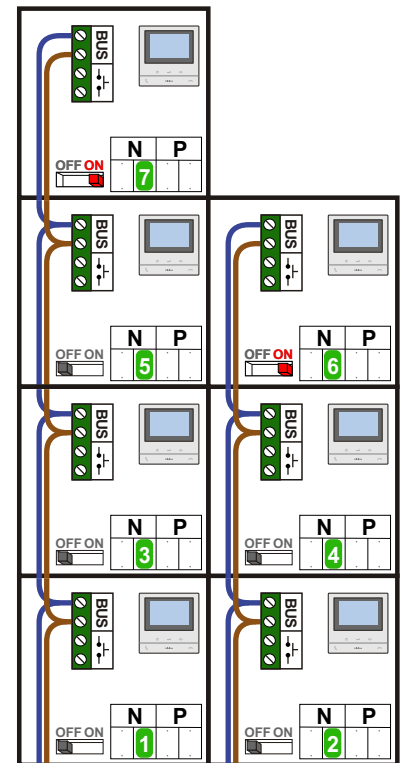

Bij monteren/demonteren spanning eraf voorkomt defecten!



Haal de spanning van het systeem als je een module monteert of demonteert

Max. 100 meter systeemkabel tot laatste videofoon

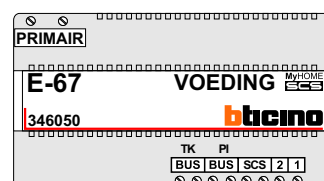

Max. 50 meter

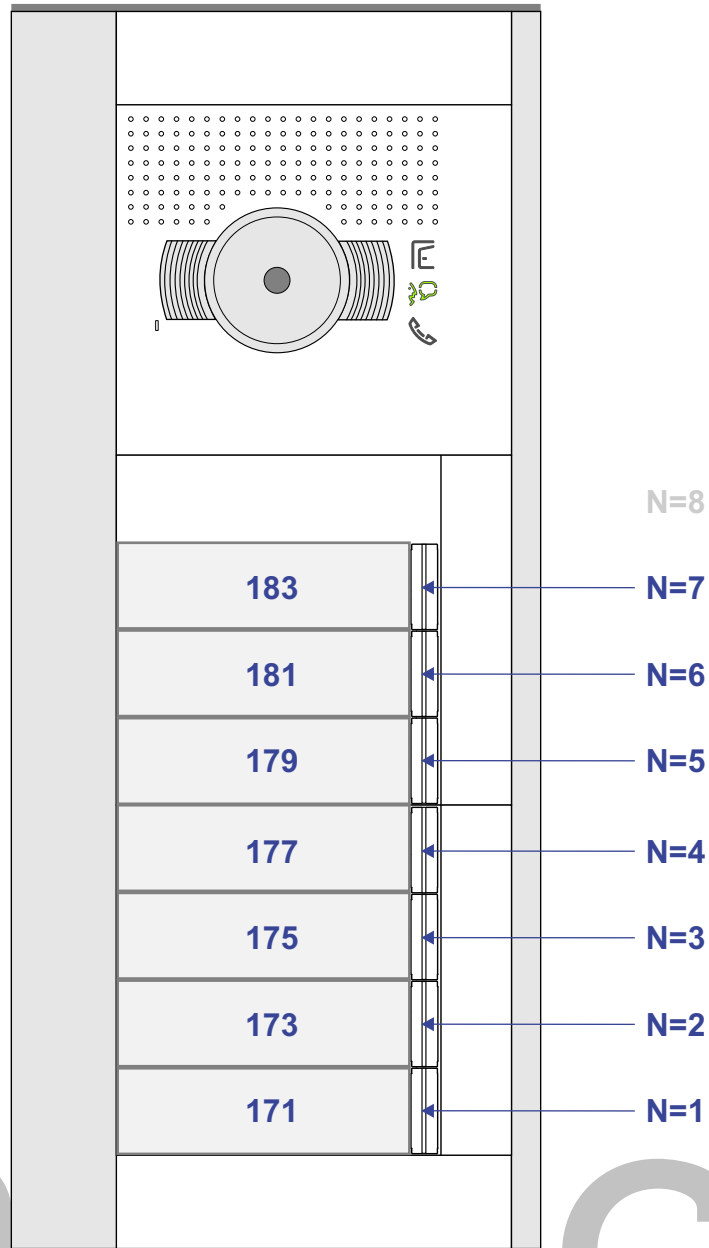



INTERCOM MADE EASY

| N-Waarde | Huisnummer | Switch-ON |
|----------|------------|-----------|
| 1 | 171 | |
| 2 | 173 | |
| 3 | 175 | |
| 4 | 177 | |
| 5 | 179 | |
| 6 | 181 | X |
| 7 | 183 | X |