

**— = systeemkabel**  
 Bij andere getwiste kabel 66% afstand!  
 Bij ongetwiste kabel max. 50 meter buitenpost naar videofoon.  
 UTP op aanvraag.

**TWEEDRAADS BUS**

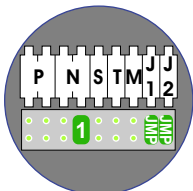

Bij monteren/demonteren spanning eraf voorkomt defecten!

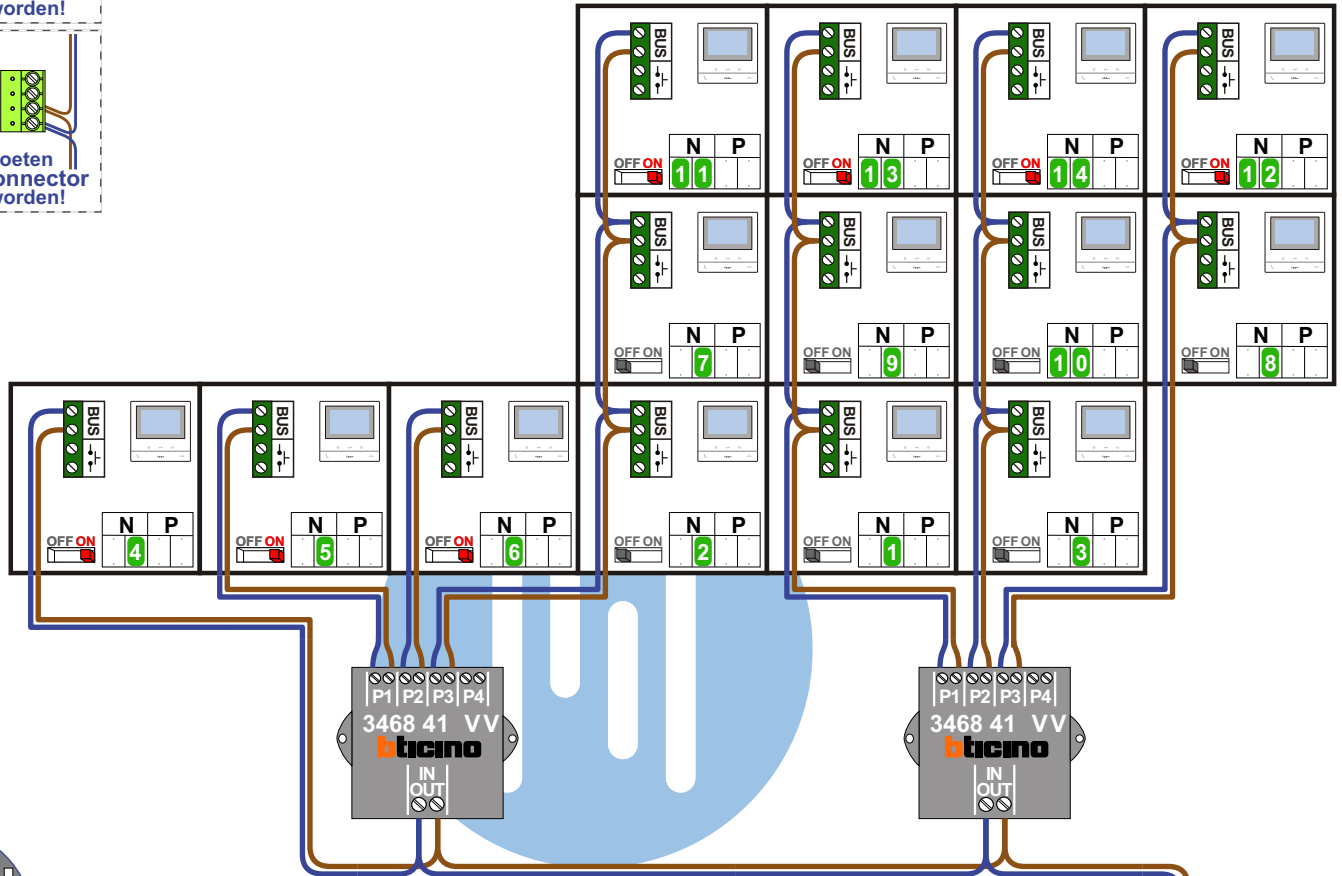
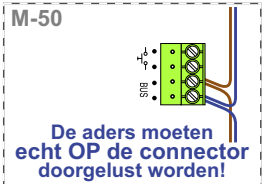

Haal de spanning van het systeem als je een module monteert of demonteert

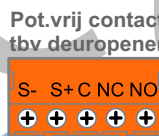
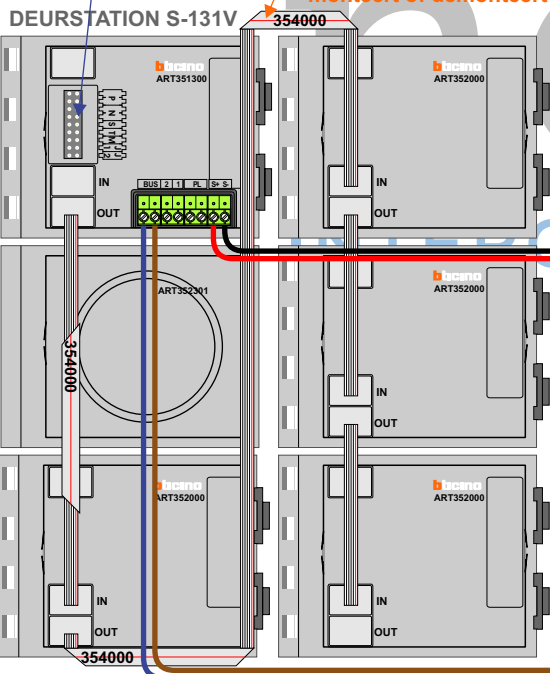

Max. 100 meter systeemkabel tot laatste videofoon

Max. 50 meter

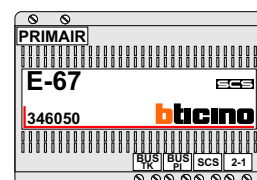

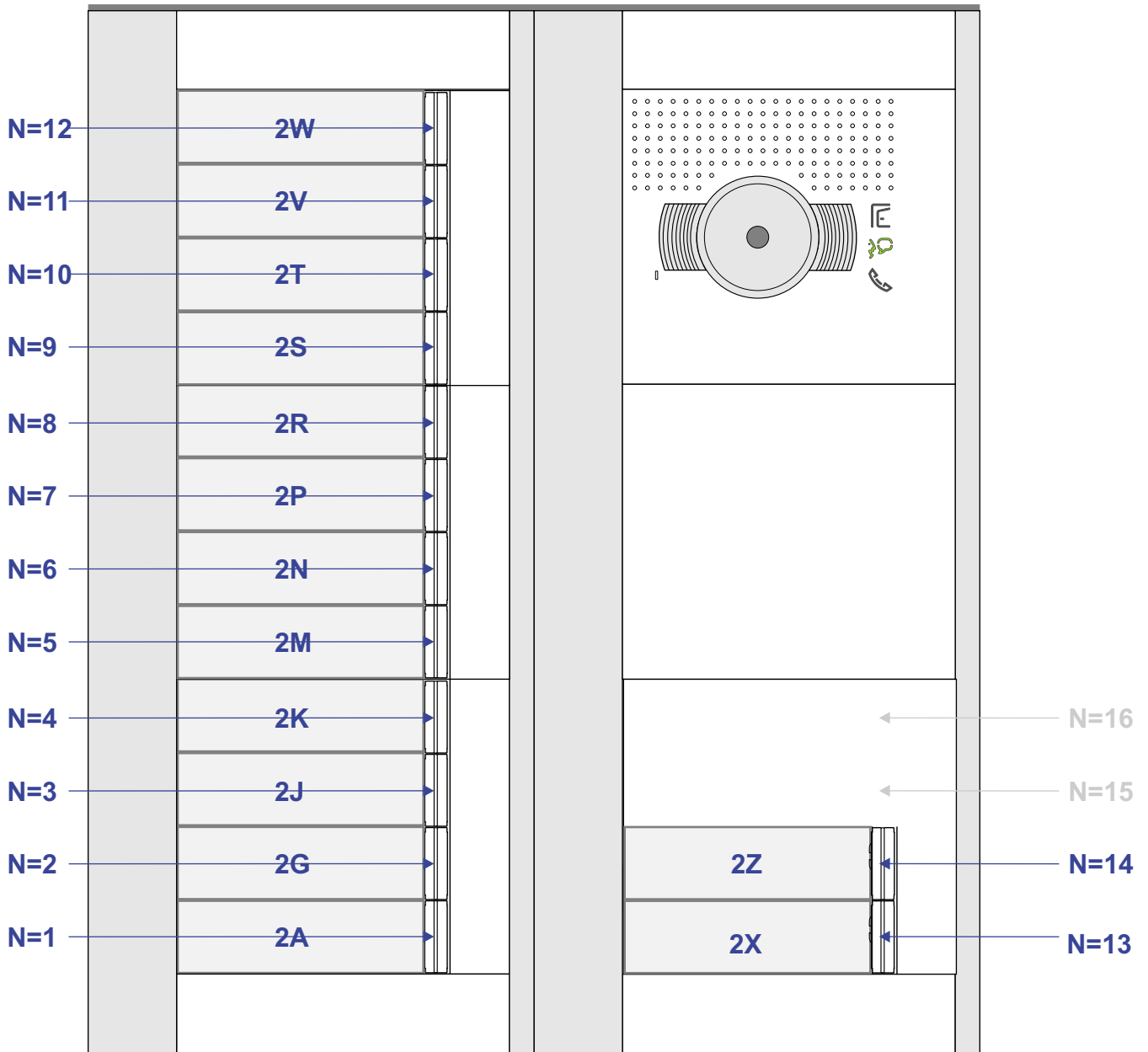

nelec  
INTERCOM MADE EASY

| N-waarde | Huisnummer | Eindweerstand |
|----------|------------|---------------|
| 1        | 2A         |               |
| 2        | 2G         |               |
| 3        | 2J         |               |
| 4        | 2K         | X             |
| 5        | 2M         | X             |
| 6        | 2N         |               |
| 7        | 2P         |               |
| 8        | 2R         |               |
| 9        | 2S         |               |
| 10       | 2T         |               |
| 11       | 2V         | X             |
| 12       | 2W         | X             |
| 13       | 2X         | x             |
| 14       | 2Z         | X             |