

**TWEEDRAADS BUS**

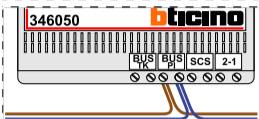

Bij monteren/demonteren **spanning eraf** voorkomt defecten!

**= systeemkabel**  
Bij andere getwiste kabel **66%** afstand!  
Bij ongetwiste kabel **max. 50 meter** buitenpost naar videofoon.  
UTP op aanvraag.



De twee stijgers **echt OP de klemmen** van E-67 aansluiten!

**VideoVerdeler**



De aders moeten **echt OP de klemmen** doorgelust worden!

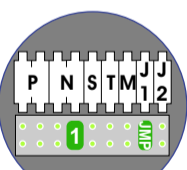

Haal de spanning van het systeem als je een module monteert of demonteert

**DEURSTATION S-131V**

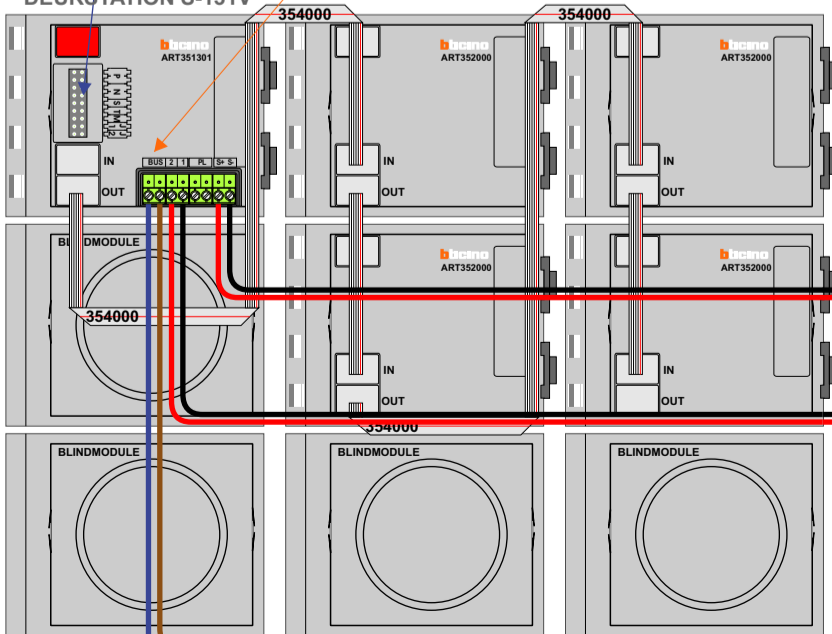

Pot.vrij contact tbv deur opener

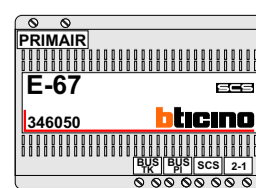
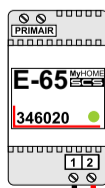
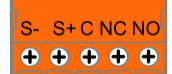

Max. 50 meter

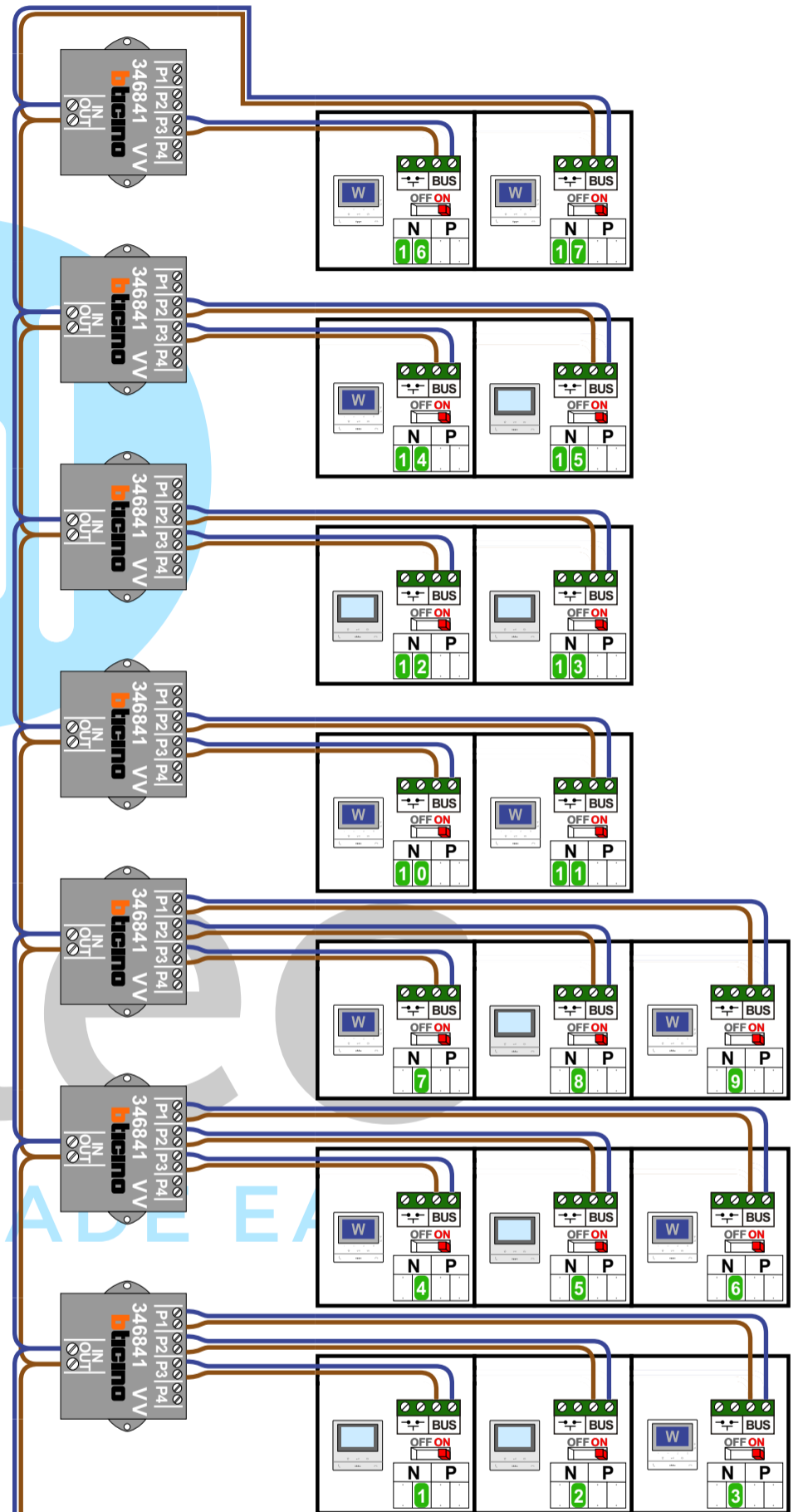

Max. 100 meter systeemkabel tot laatste videofoon

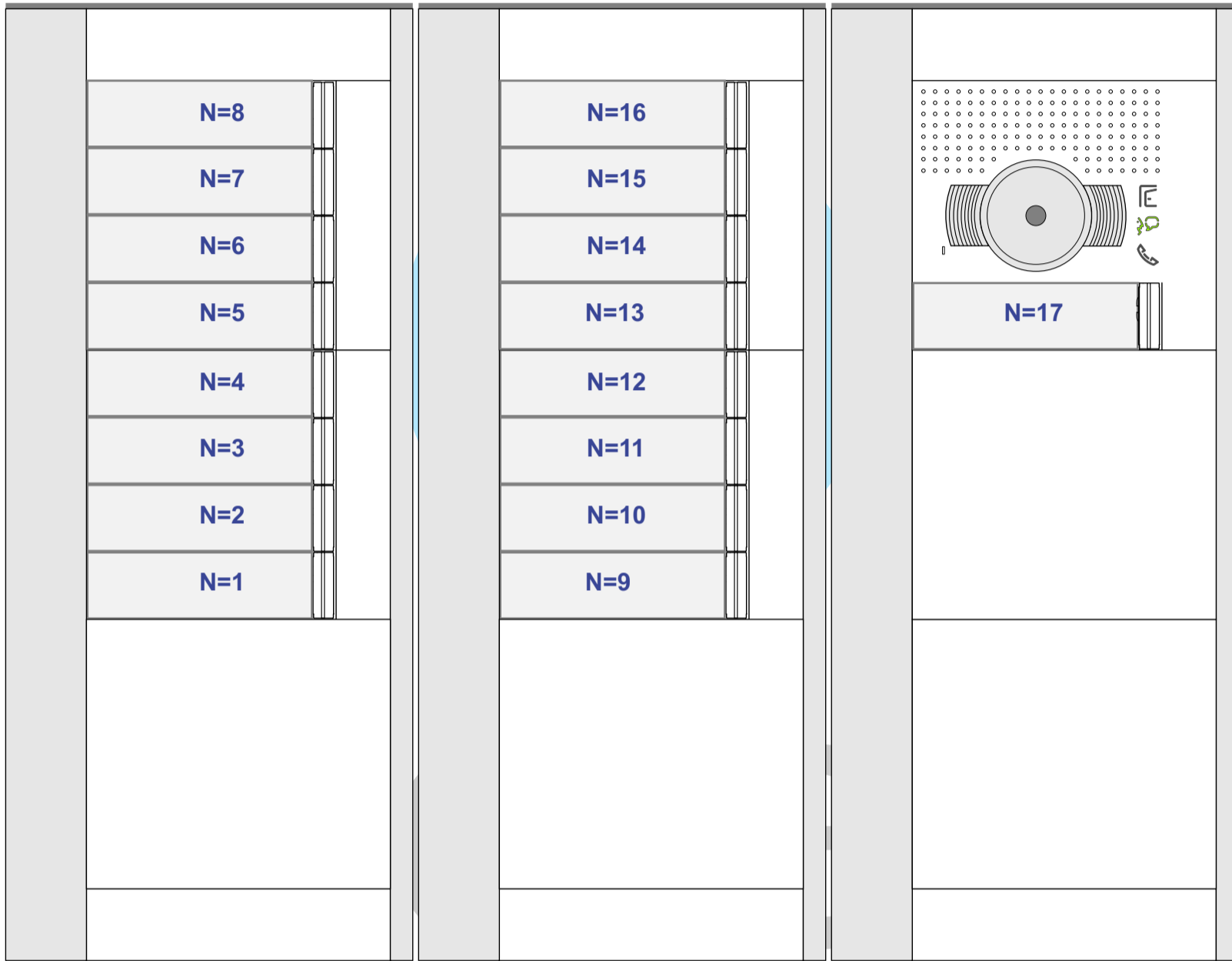

## INTERCOM MADE EASY

N-waarde	Huisnummer	Eindweerstand	Videofoon
1	46	X	M-50B
2	48	X	M-50B
3	50	X	M-50W ifi
4	52	X	M-50W ifi
5	54	X	M-50B
6	56	X	M-50W ifi
7	58	X	M-50W ifi
8	60	X	M-50B
9	62	X	M-50W ifi
10	64	X	M-50W ifi
11	66	X	M-50W ifi
12	68	X	M-50B
13	70	X	M-50B
14	72	X	M-50W ifi
15	74	X	M-50B
16	76	X	M-50W ifi
17	78	X	M-50W ifi