

— = systeemkabel
 Bij andere getwiste kabel 66% afstand!
 Bij ongetwiste kabel max. 50 meter buitenpost naar videofoon.
 UTP op aanvraag.

DD8 digitizer: flatcable

 Connector van flatcable nokje juiste kant op bij aansluiten op DD8

Digitizers & flatcables

 Niet monteren/demonteren onder spanning
 Beldrukkers mogen wel

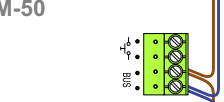
M-50

 De aders moeten echt OP de connector doorgelust worden!

VideoVerdeler

 De aders moeten echt OP de klemmen doorgelust worden!

TWEEDRAADS BUS

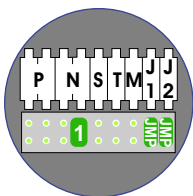
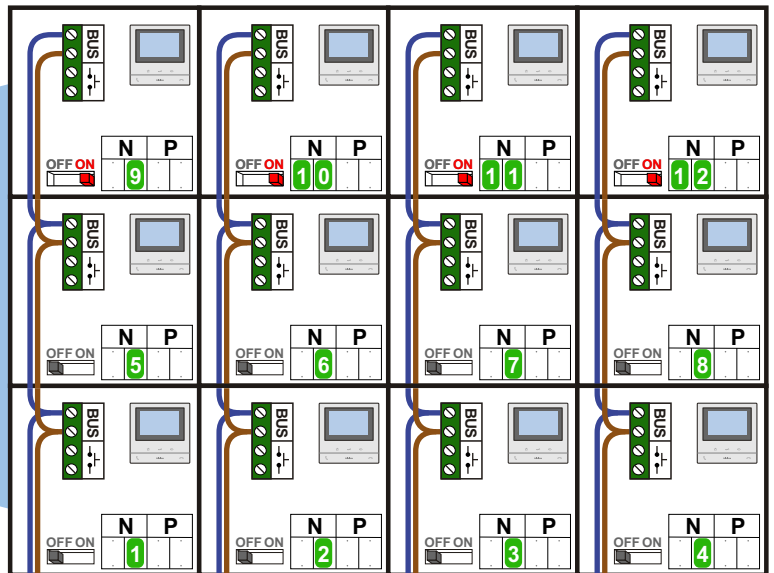
 Bij monteren/demonteren spanning eraf voorkomt defecten!



Haal de spanning van het systeem als je een module monteert of demonteert

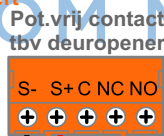
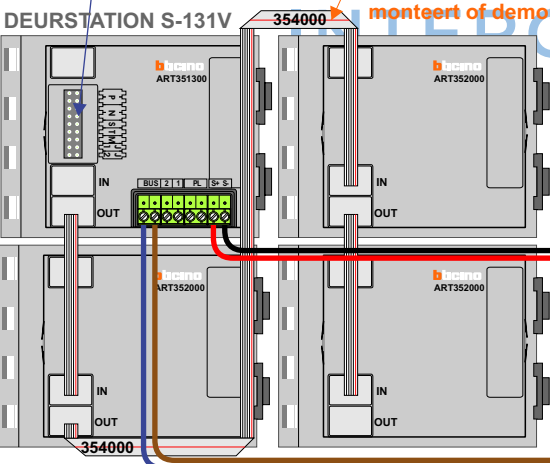

Max. 100 meter systeemkabel tot laatste videofoon

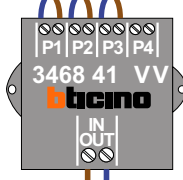
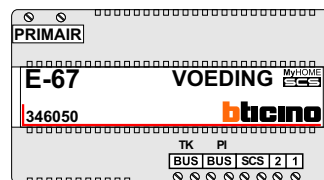

Max. 50 meter

TWEEDRAADS BUS



Bij monteren/demonteren
spanning eraf
voorkomt defecten!

Entree 1: huisnummer 42 t/m 64

N-Waarde	Huisnummer	Switch-ON
1	42	
2	44	
3	46	
4	48	
5	50	
6	52	
7	54	
8	56	
9	58	X
10	60	X
11	62	X
12	64	X

Entree 2: huisnummer 66 t/m 88

N-Waarde	Huisnummer	Switch-ON
1	66	
2	68	
3	70	
4	72	
5	74	
6	76	
7	78	
8	80	
9	82	X
10	84	X
11	86	X
12	88	X

