

— = systeemkabel
Bij kabel 2 x 1 mm²:
180% afstand!
Bij kabel 2 x 0,28 mm²:
60% afstand!
UTP op aanvraag.

Digitizers & flatcables

Niet monteren/demonteren
onder spanning
Bedrukkers mogen wel

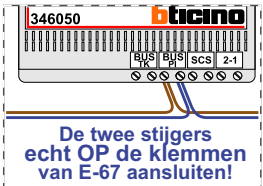

TWEEDRAADS BUS
 
Bij monteren/demonteren
spanning eraf
voorkomt defecten!

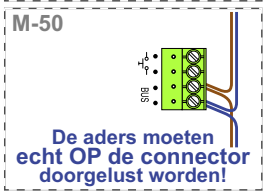

nelec

INTERCOM MADE EASY

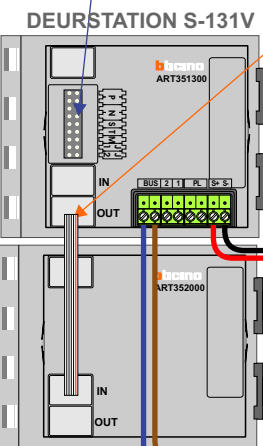
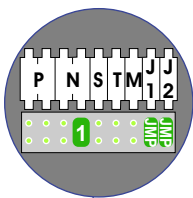
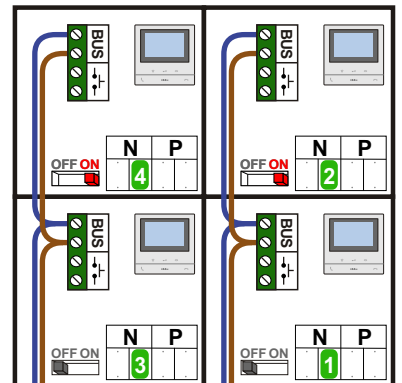

Haal de spanning van het
systeem als je een module
monteert of demonteert

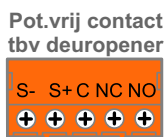

Max. 100 meter systeem-
kabel tot laatste videofoon

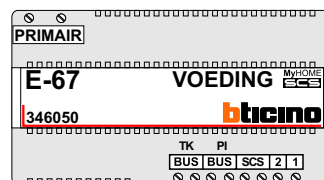

Max. 50 meter

N-Waarde	Huisnummer	Switch-ON
1	20	
2	22	X
3	24	
4	26	X

N-Waarde	Huisnummer	Switch-ON
1	52	
2	54	X
3	56	
4	58	X

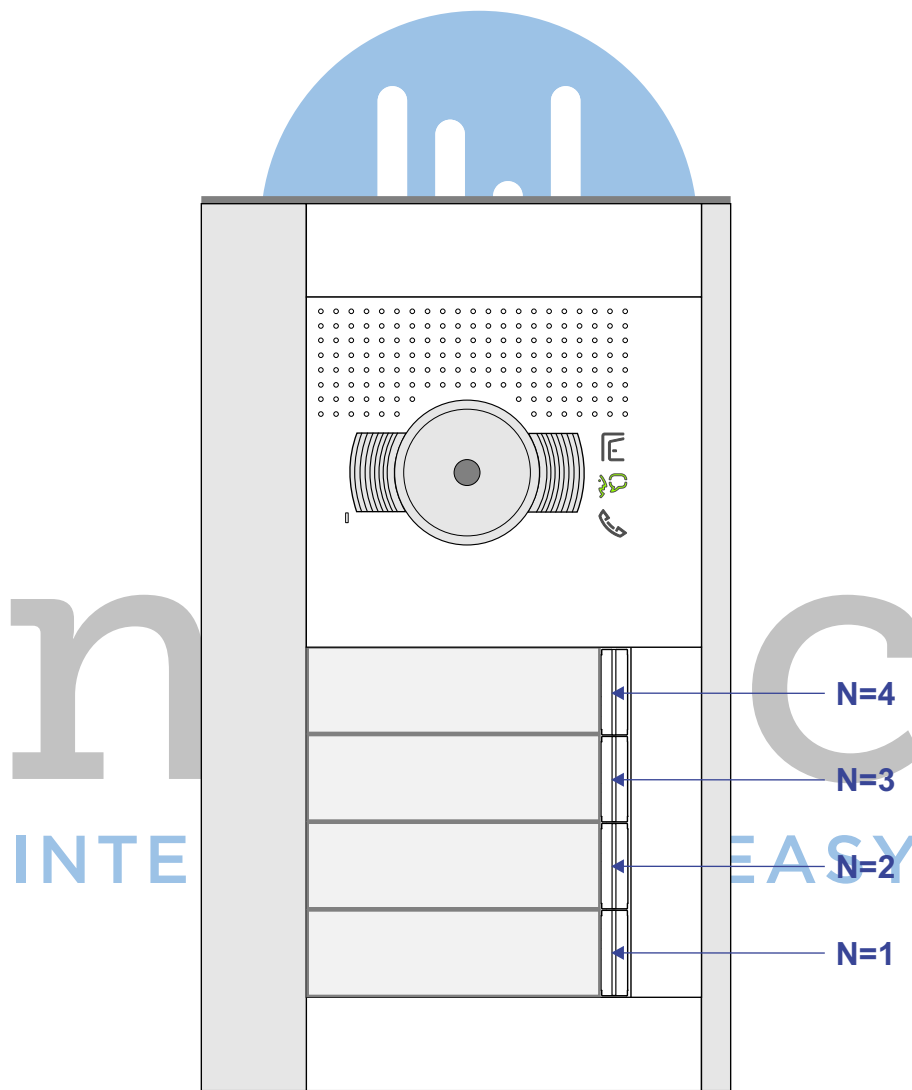

— = systeemkabel
Bij kabel 2 x 1 mm²:
180% afstand!
Bij kabel 2 x 0,28 mm²:
60% afstand!
UTP op aanvraag.

Digitizers & flatcables

Niet monteren/demonteren
onder spanning
Bedrukkers mogen wel

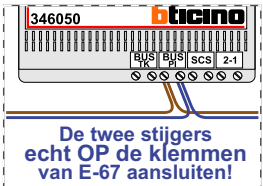

TWEEDRAADS BUS
 
Bij monteren/demonteren
spanning eraf
voorkomt defecten!

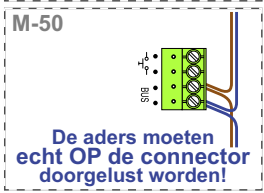

nelec

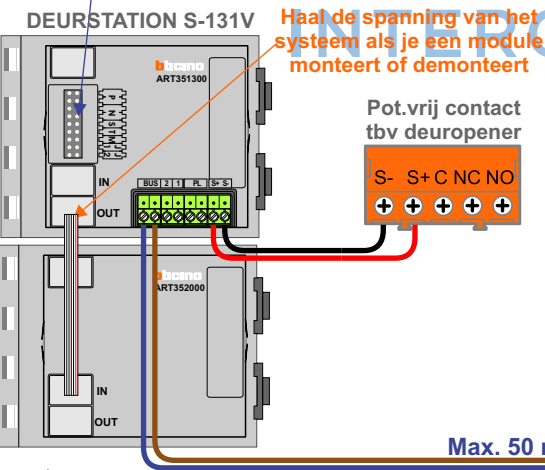
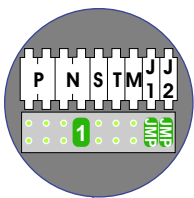

Max. 100 meter systeem-
kabel tot laatste videofoon

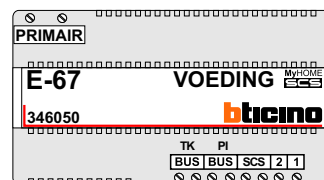

Max. 50 meter

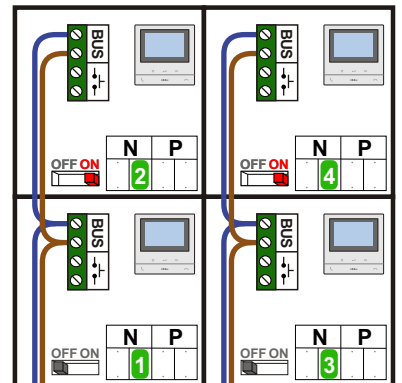

N-Waarde	Huisnummer	Switch-ON
1	15	
2	15-1	X
3	17	
4	17-1	X

N-Waarde	Huisnummer	Switch-ON
1	23	
2	23-1	X
3	25	
4	25-1	X

