

TWEEDRAADS BUS

Bij monteren/demonteren spanning eraf voorkomt defecten!

Digitizers & flatcables

Niet monteren/demonteren onder spanning
Beldrukkers mogen wel

DD8 digitizer: flatcable



Connector van flatcable nokje juiste kant op bij aansluiten op DD8

 = systeemkabel

Bij andere getwiste kabel 66% afstand!
Bij ongetwiste kabel max. 50 meter buitenpost naar videofoon.
UTP op aanvraag.

M-50



De aders moeten echt OP de connector doorgelust worden!

VideoVerdeler



De aders moeten echt OP de klemmen doorgelust worden!



nelec
INTERCOM MADE EASY

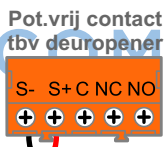
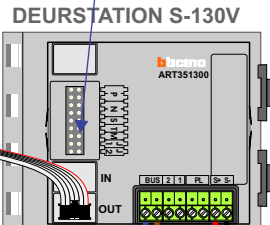
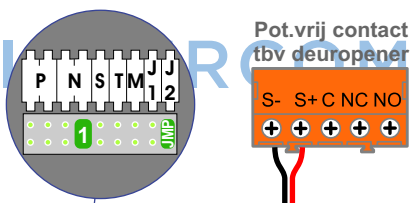
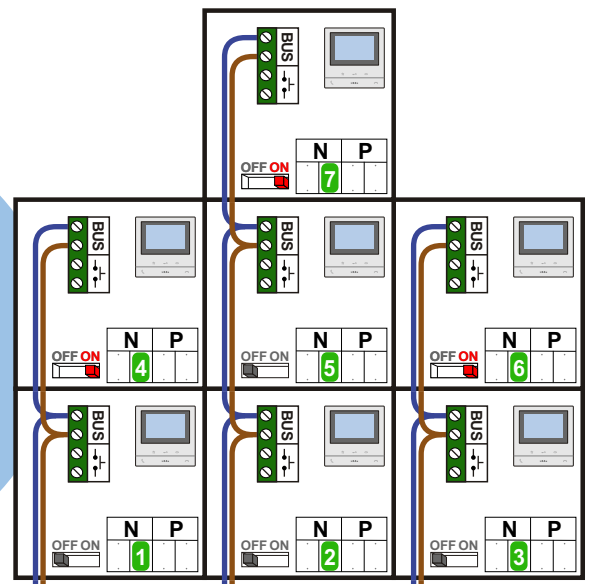

Max. 100 meter systeemkabel tot laatste videofoon

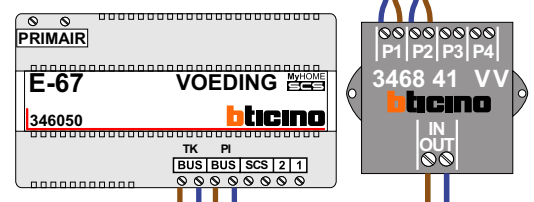

nokjes connectoren wijzen naar elkaar

Max. 50 meter

N-Waarde	Huisnummer	Switch-ON
1	1	
2	3	
3	5	
4	7	X
5	9	
6	11	X
7	13	X



nelec
INTERCOM MADE EASY