

TWEEDRAADS BUS



Bij monteren/demonteren spanning eraf voorkomt defecten!

Digitizers & flatcables



Niet monteren/demonteren onder spanning
Beldrukkers mogen wel

— = systeemkabel

Bij andere getwiste kabel 66% afstand!
Bij ongetwiste kabel max. 50 meter buitenpost naar videofoon.
UTP op aanvraag.

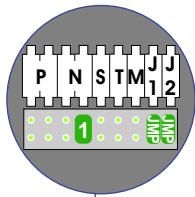

Haal de spanning van het systeem als je een module monteert of demonteert

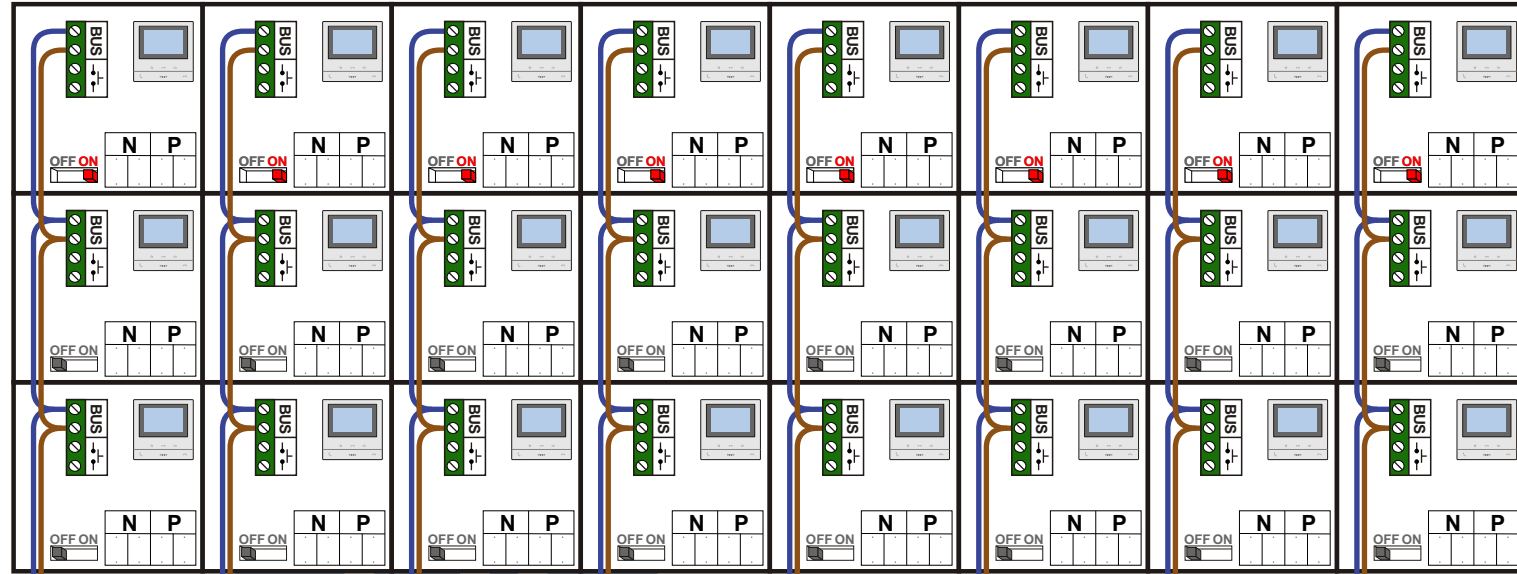
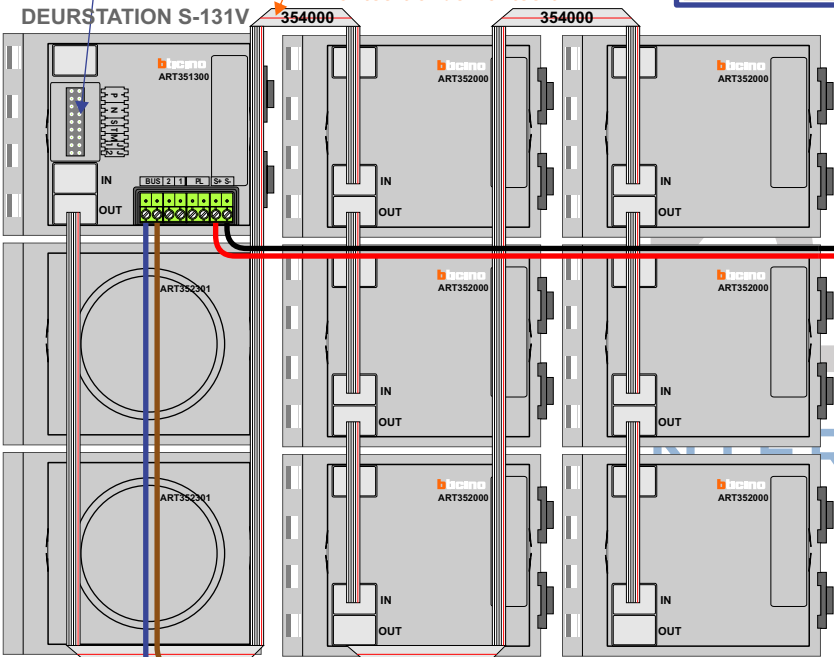

Pot.vrij contact tbv deuropener

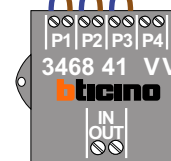
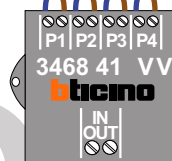
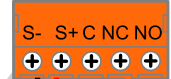

Max. 100 meter systeemkabel tot laatste videofoon



Max. 50 meter

M-50

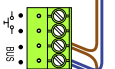

De aders moeten echt OP de connector doorgelust worden!

VideoVerdeler



De aders moeten echt OP de klemmen doorgelust worden!

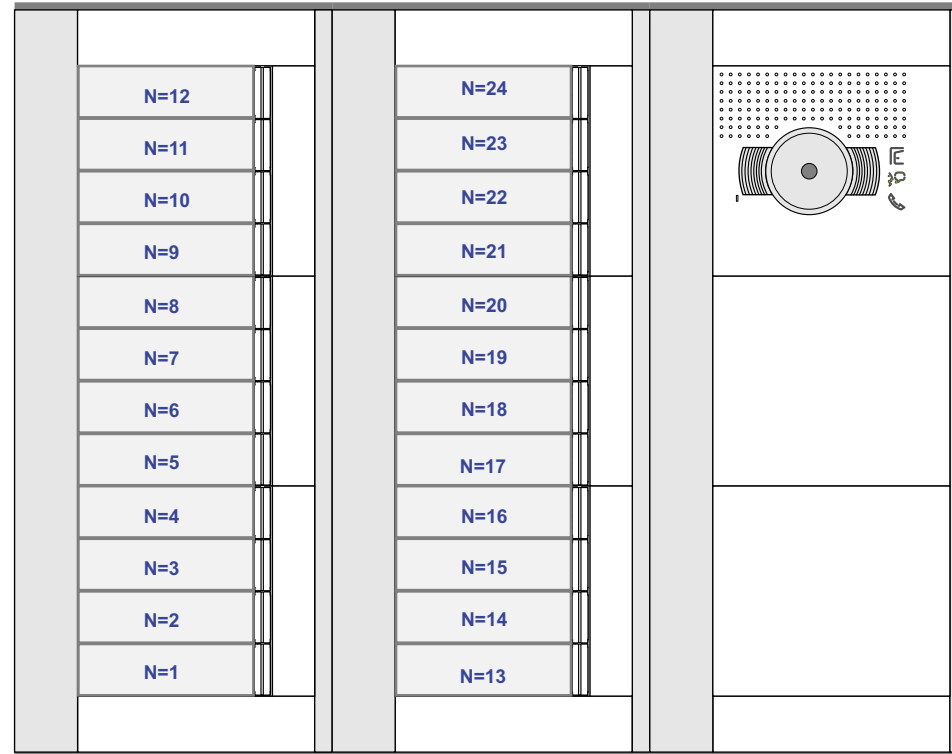

nelec
INTERCOM MADE EASY