

— = systeemkabel
Bij kabel 2 x 1 mm²:
180% afstand!
Bij kabel 2 x 0,28 mm²:
60% afstand!
UTP op aanvraag.

TWEEDRAADS BUS



Bij monteren/demonteren
spanning eraf
voorkomt defecten!

M-50

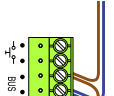

De aders moeten
echt **OP** de connector
doorgelust worden!

DD8 digitizer: flatcable

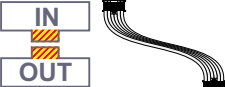

Connector van flatcable
nokje juiste kant op
bij aansluiten op DD8

Digitizers & flatcables



Niet monteren/demonteren
onder spanning
Beldrukkers mogen wel

Haal de spanning van het
systeem als je een digitizer
monteert of demonteert

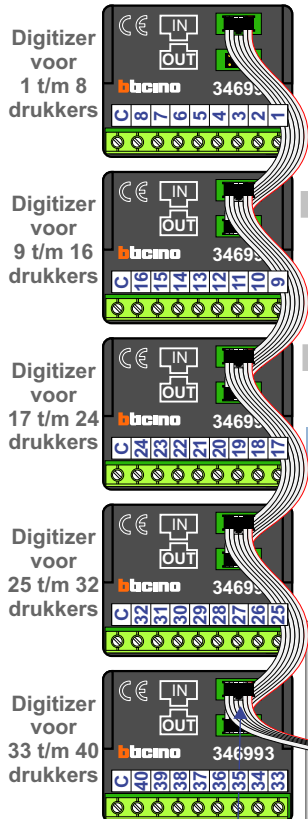

nokjes connectoren
wijzen naar elkaar

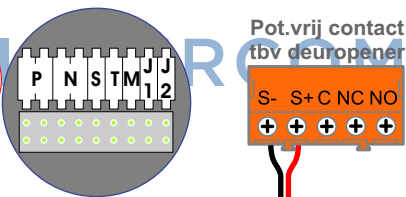
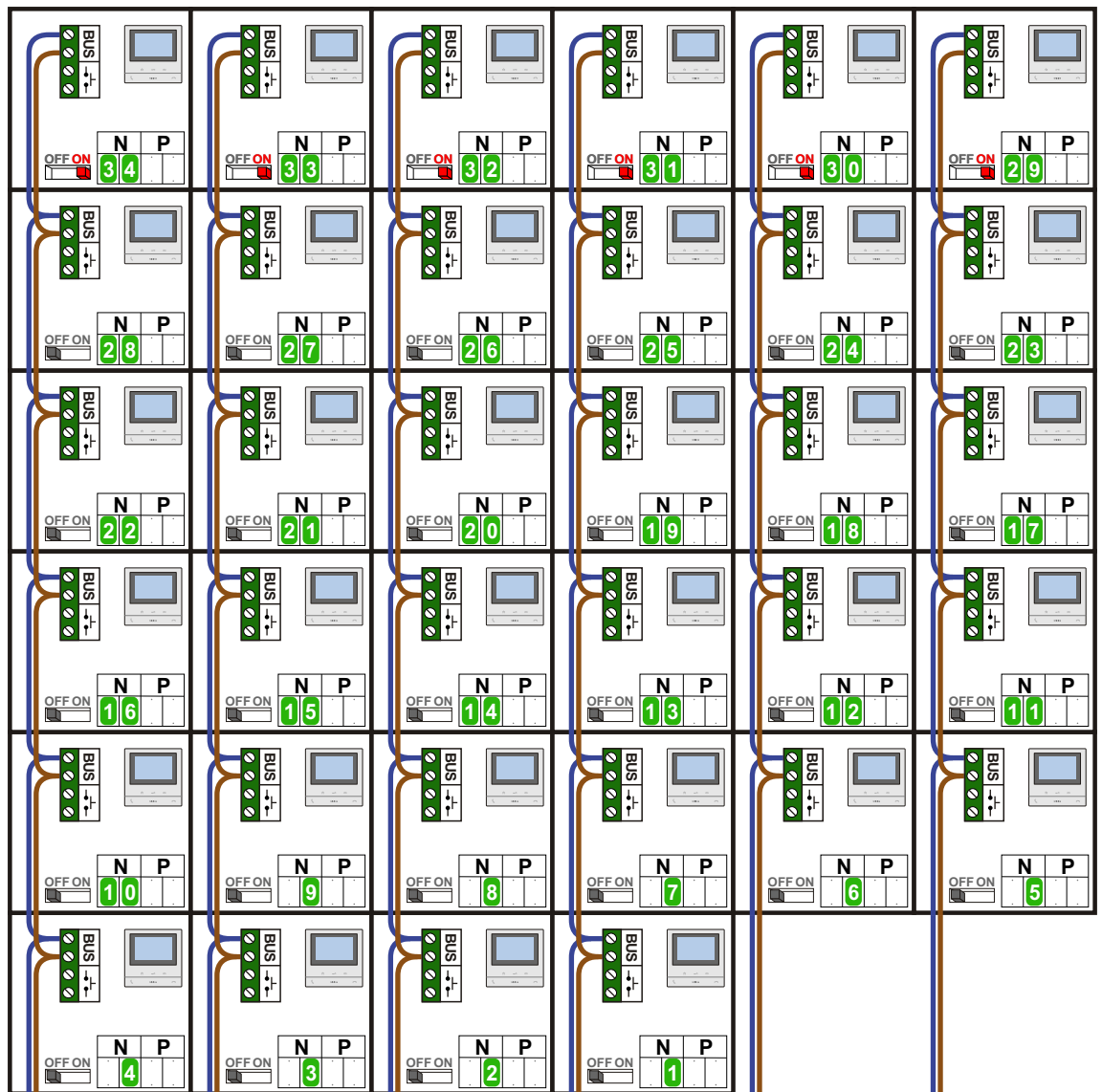

DEURSTATION S-130V

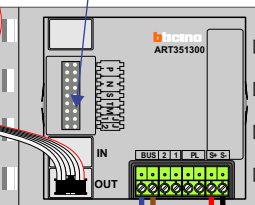

Max. 50 meter

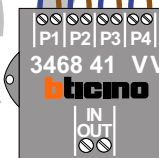

Max. 100 meter systeem-
kabel tot laatste videofoon

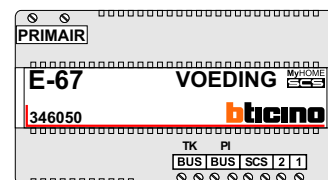

N-waarde	Huisnummer	N-waarde
1	104-1	
2	104-2	
3	104-3	
4	104-4	
5	104-101	
6	104-102	
7	104-103	
8	104-104	
9	104-105	
10	104-106	
11	104-201	
12	104-202	
13	104-203	
14	104-204	
15	104-205	
16	104-206	
17	104-301	
18	104-302	
19	104-303	
20	104-304	
21	104-305	
22	104-306	
23	104-401	
24	104-402	
25	104-403	
26	104-404	
27	104-405	
28	104-406	
29	104-501	X
30	104-502	X
31	104-503	X
32	104-504	X
33	104-505	X
34	104-506	X

nelec
INTERCOM MADE EASY