



**— = systeemkabel**  
 Bij andere getwiste kabel 66% afstand!  
 Bij ongetwiste kabel max. 50 meter buitenpost naar videofoon.  
 UTP op aanvraag.

**DD8 digitzer: flatcable**



Connector van flatcable nokje juiste kant op bij aansluiten op DD8

**Digitizers & flatcables**



Niet monteren/demonteren onder spanning  
 Belrukkers mogen wel

**TWEEDRAADS BUS**



Bij monteren/demonteren spanning eraf voorkomt defecten!

**M-50**

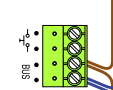

De aders moeten echt OP de connector doorgelust worden!

**VideoVerdeler**



De aders moeten echt OP de klemmen doorgelust worden!

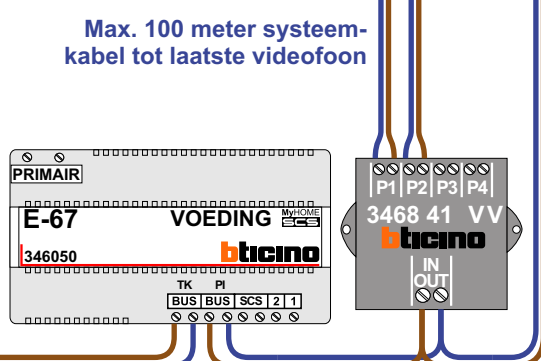
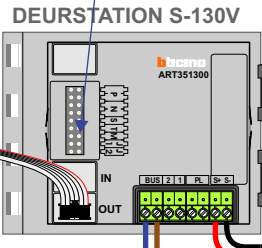
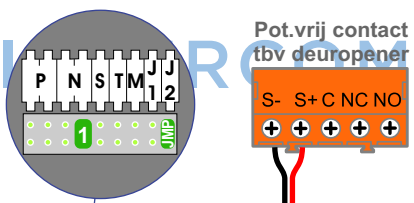
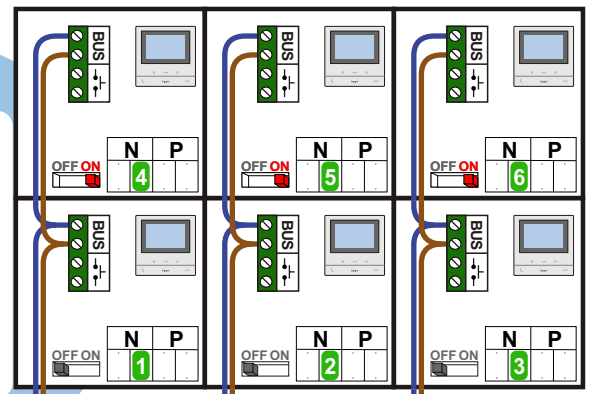
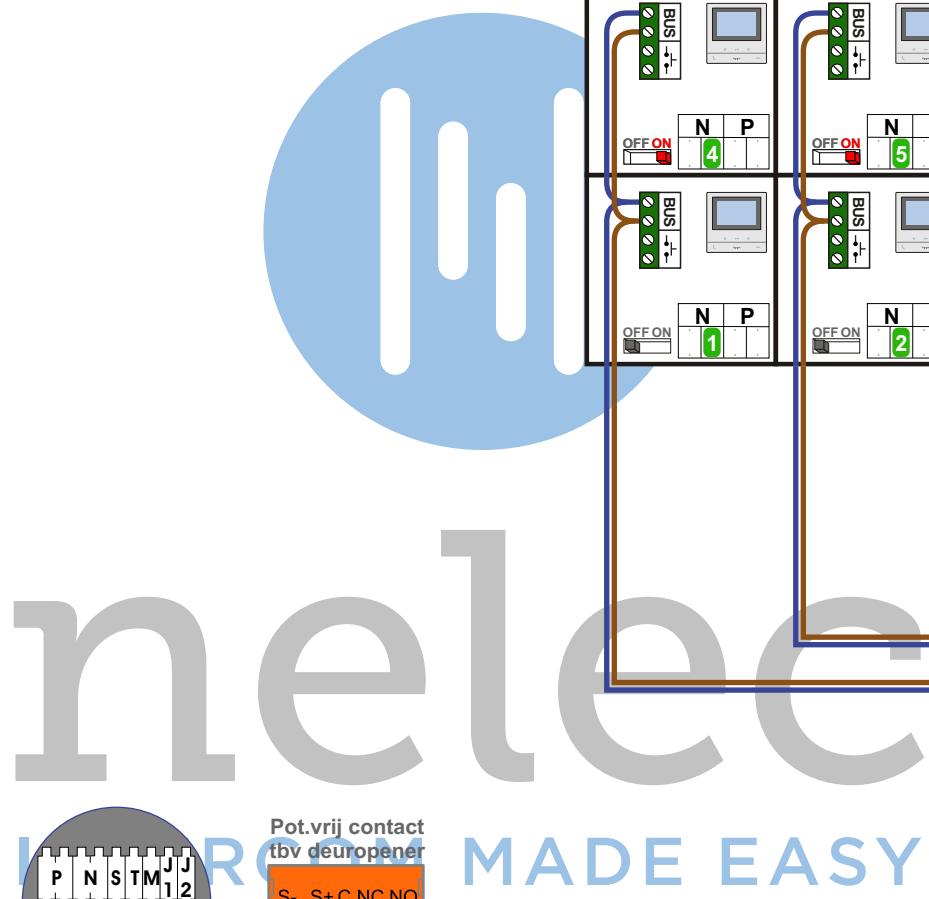

| N-waarde | Huisnummer | Switch-ON |
|----------|------------|-----------|
| 1        | 9          |           |
| 2        | 11         |           |
| 3        | 13         |           |
| 4        | 15         | X         |
| 5        | 17         | X         |
| 6        | 19         | X         |



nelec  
INTERCOM MADE EASY