

— = systeemkabel
Bij kabel 2 x 1 mm²:
180% afstand!
Bij kabel 2 x 0,28 mm²:
60% afstand!
UTP op aanvraag.

Digitizers & flatcables

Niet monteren/demonteren
onder spanning
Bedrukkers mogen wel

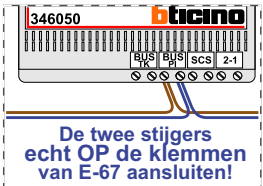

TWEEDRAADS BUS
 
Bij monteren/demonteren
spanning eraf
voorkomt defecten!

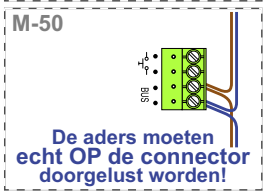

nelec

INTERCOM MADE EASY

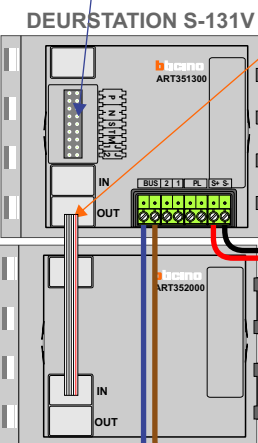
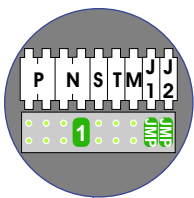
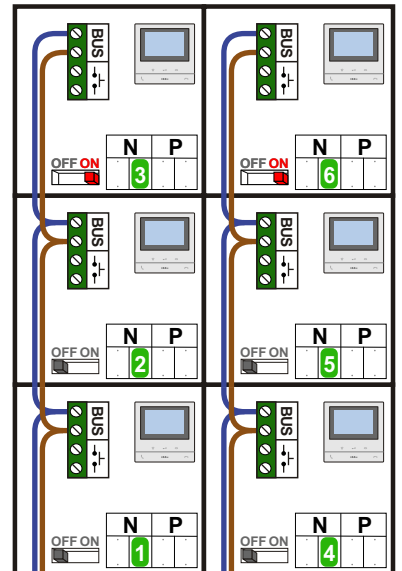

Haal de spanning van het
systeem als je een module
monteert of demonteert

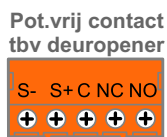

Max. 100 meter systeem-
kabel tot laatste videofoon

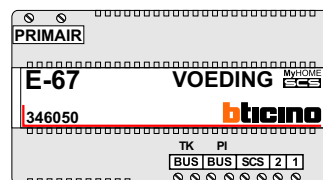

Max. 50 meter

N-Waarde	Huisnummer	Switch-ON
1	3	
2	3-11	
3	3-13	X
4	5	
5	5-11	
6	5-13	X

