

— = systeemkabel
 Bij kabel 2 x 1 mm²:
 180% afstand!
 Bij kabel 2 x 0,28 mm²:
 60% afstand!
 UTP op aanvraag.

Digitizers & flatcables



Niet monteren/demonteren onder spanning
 Belrukkers mogen wel

TWEEDRAADS BUS



Bij monteren/demonteren spanning eraf voorkomt defecten!

M-50

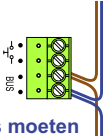

De aders moeten echt OP de connector doorgelust worden!



nelec

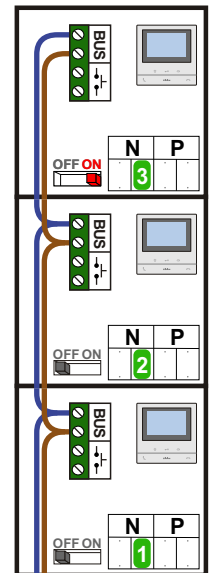
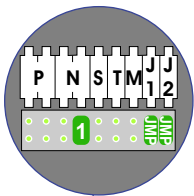

Haal de spanning van het systeem als je een module monteert of demonteert

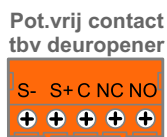
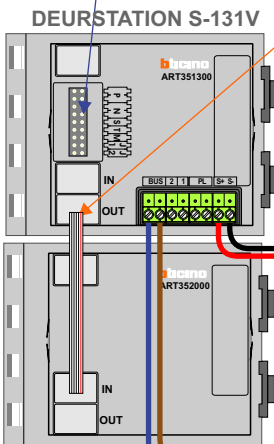

Max. 100 meter systeemkabel tot laatste videofoon

Max. 50 meter

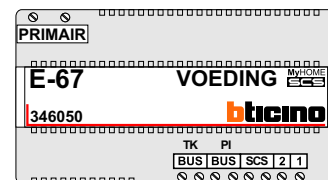

— = systeemkabel
Bij kabel 2 x 1 mm²:
180% afstand!
Bij kabel 2 x 0,28 mm²:
60% afstand!
UTP op aanvraag.

Digitizers & flatcables

Niet monteren/demonteren
onder spanning
Bedrukkers mogen wel

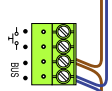
M-50

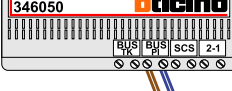
De aders moeten
echt OP de connector
doorgelust worden!

346050 bticino

De twee stijgers
echt OP de klemmen
van E-67 aansluiten!

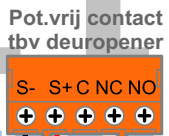
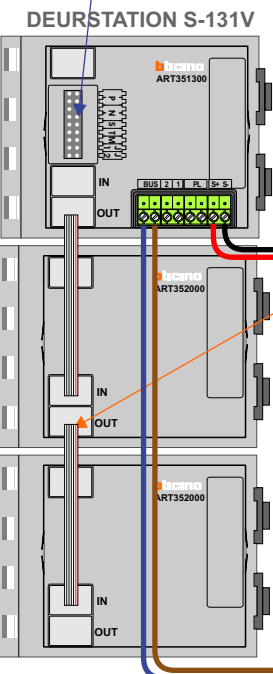
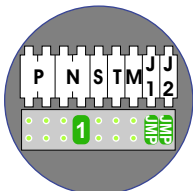
TWEEDRAADS BUS

Bij monteren/demonteren
spanning eraf
voorkomt defecten!

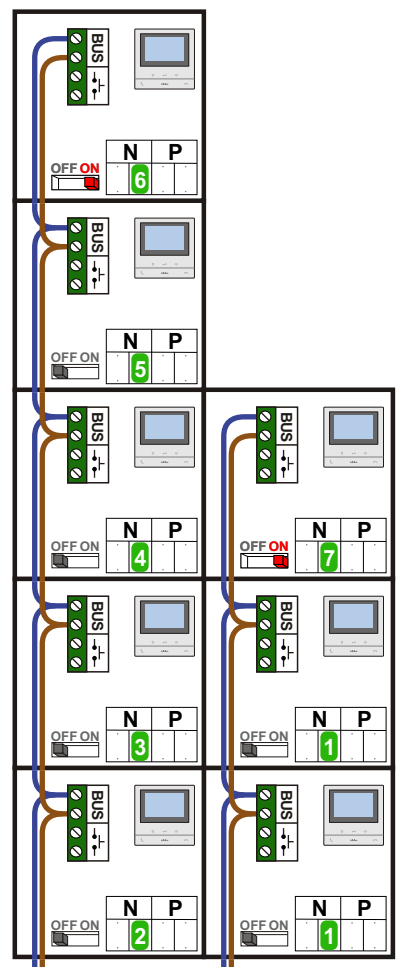
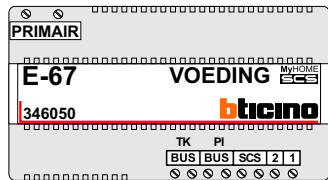

Haal de spanning van het
systeem als je een module
monteert of demonteert



nelec
INTERCOM MADE EASY

Max. 100 meter systeem-
kabel tot laatste videofoon

Max. 50 meter

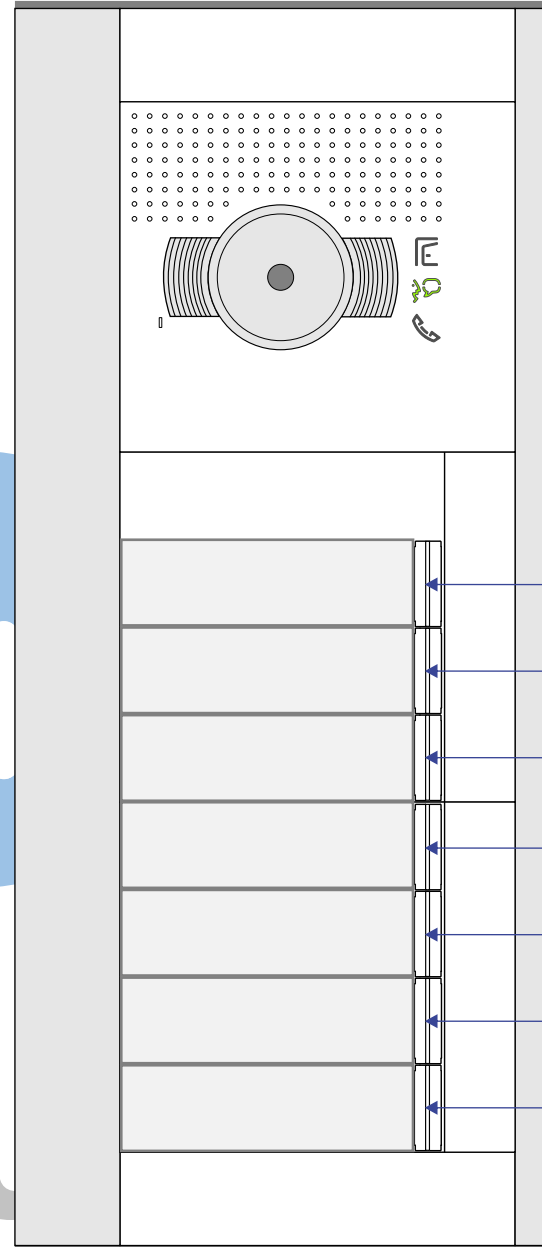
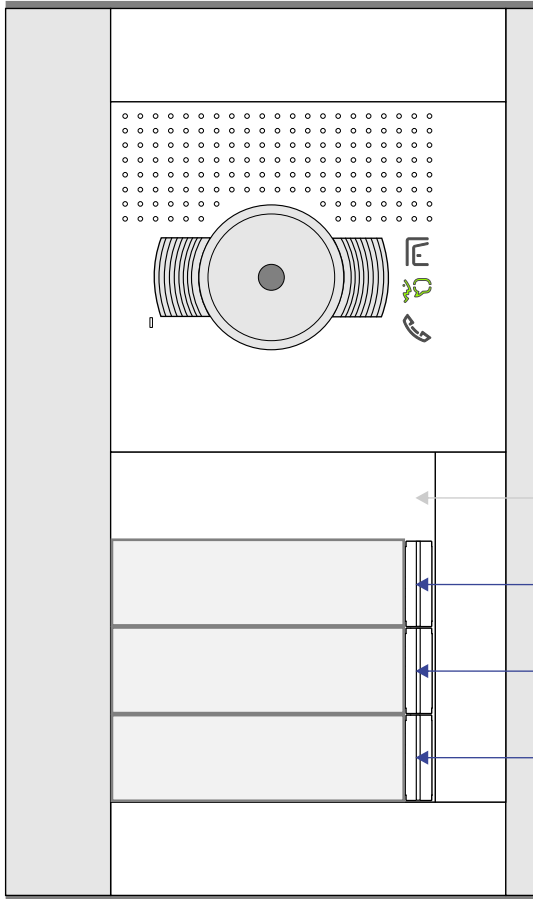

nelec
INTERCOM MADE EASY