

TWEEDRAADS BUS

Bij monteren/demonteren spanning eraf voorkomt defecten!

= systeemkabel
Bij andere getwiste kabel 66% afstand!
Bij ongetwiste kabel max. 50 meter buitenpost naar videofoon.
UTP op aanvraag.

Digitizers & flatcables



Niet monteren/demonteren onder spanning
Beldrukkers mogen wel

DD8 digitzer: flatcable



Connector van flatcable nokje juiste kant op bij aansluiten op DD8

M-300 EOS

Español
Deutsch
Nederlands

Videofoon werkt pas na instellen van taal, datum en tijd.

M-50e M-50W

Bij hulpvoeding op 1-2: zet switch op ON

 2-1
ON OFF

Uitrit Parkeergarage
BUIENPOST S-120A

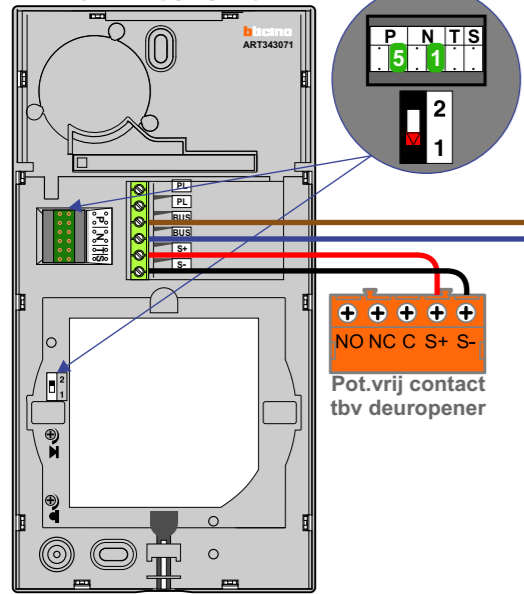

Personeelsgang
BUIENPOST S-120V

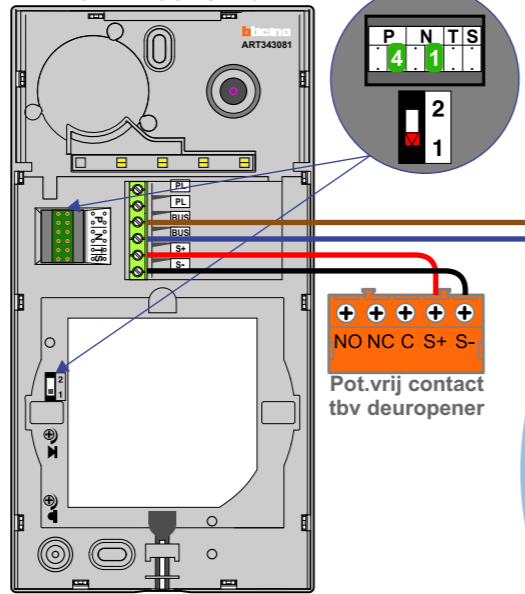

Leveranciers

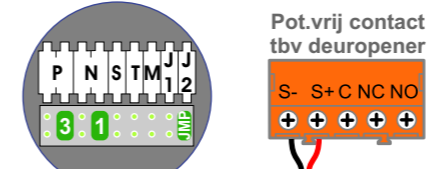

Pot.vrij contact tbv deuropener

S- S+ C NC NO

Haal de spanning van het systeem als je de digitizer monteert of demonteert

Digitizer voor 1 t/m 8 drukkers

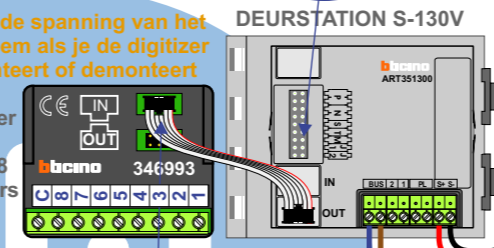

Vergaderruimte

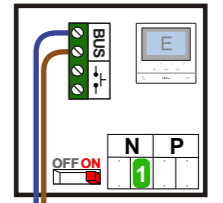

Max. 100 meter systeemkabel tot laatste videofoon

Receptie

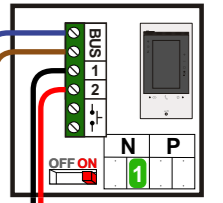

Inrit Parkeergarage
BUIENPOST S-120V

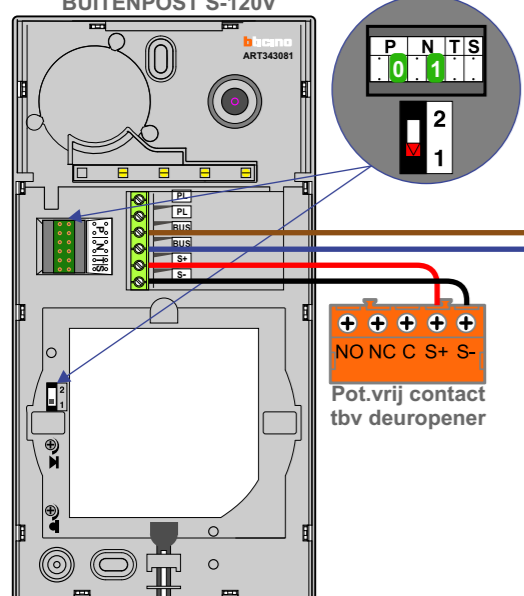

Vlamstraat
BUIENPOST S-120V

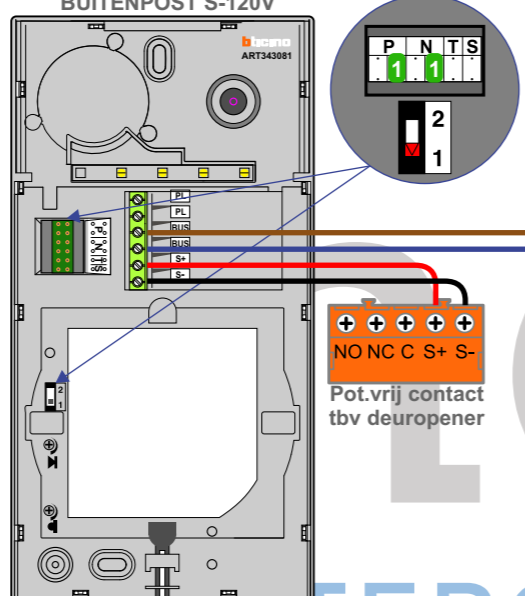

Stationstraat
BUIENPOST S-120V

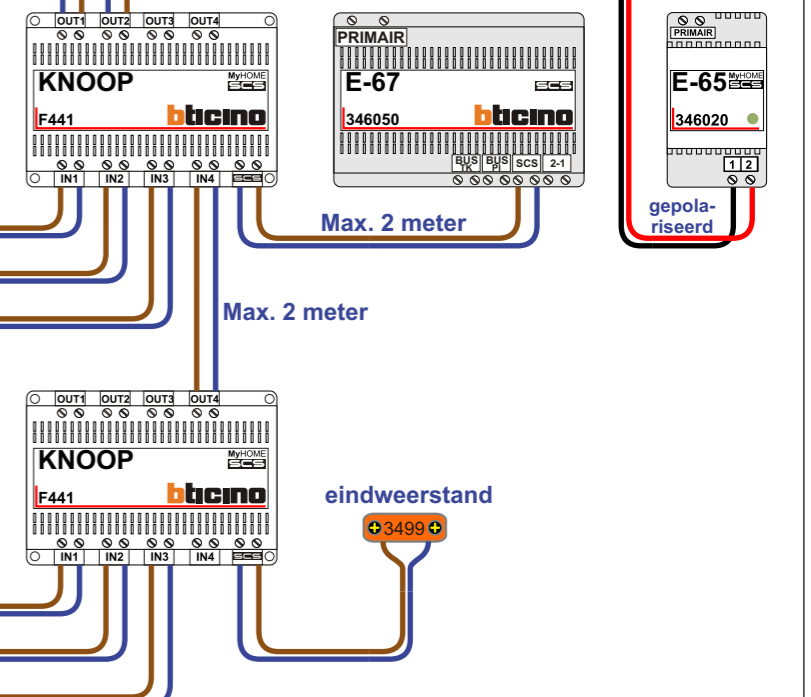
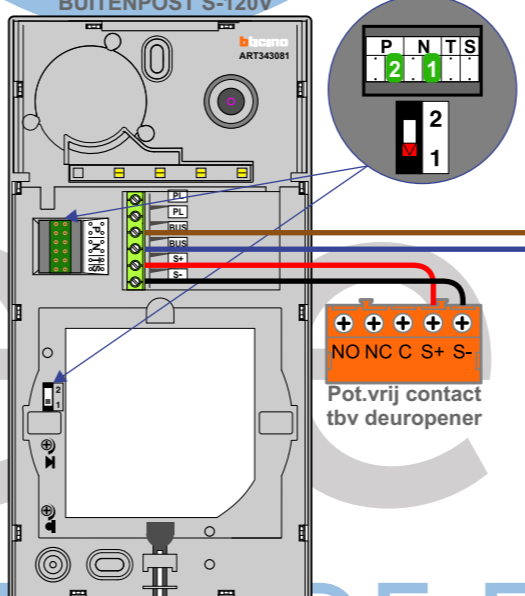

INTERCOM MADE EASY