

— = systeemkabel
 Bij kabel 2 x 1 mm²:
 180% afstand!
 Bij kabel 2 x 0,28 mm²:
 60% afstand!
 UTP op aanvraag.

DD8 digitizer: flatcable



Connector van flatcable
 nokje juiste kant op
 bij aansluiten op DD8

Digitizers & flatcables



Niet monteren/demonten
 onder spanning
 Beldrukkers mogen wel

M-50

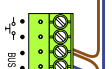

De anders moeten
 echt OP de connector
 doorgelust worden!

VideoVerdeler



De anders moeten
 echt OP de klemmen
 doorgelust worden!

TWEEDRAADS BUS



Bij monteren/demonten
 spanning eraf
 voorkomt defecten!

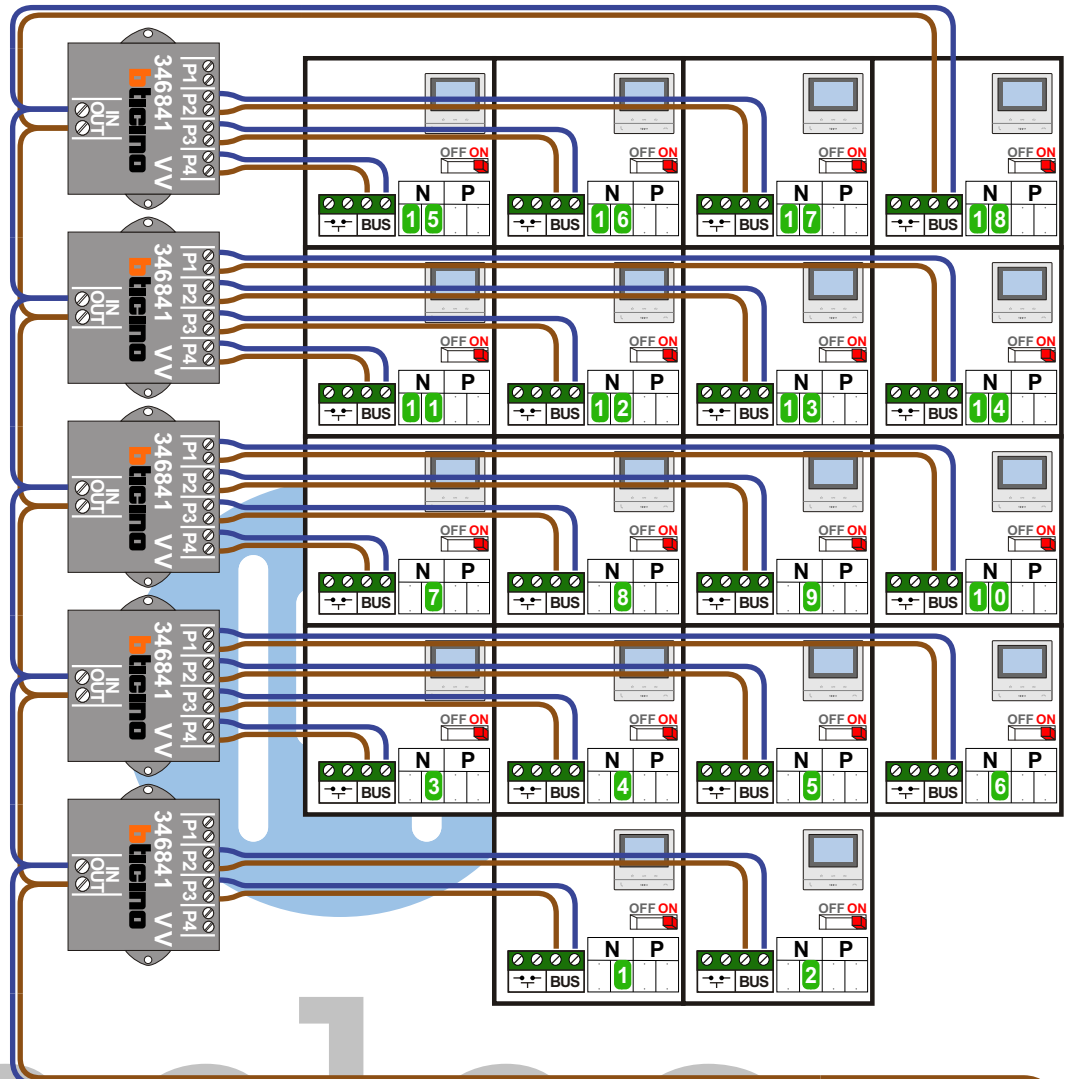

Haal de spanning van het
 systeem als je een digitizer
 monteert of demonteert

Digitizer
 voor
 1 t/m 8
 drukkers

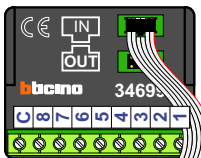

Digitizer
 voor
 9 t/m 16
 drukkers

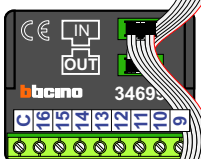

Digitizer
 voor
 17 t/m 24
 drukkers

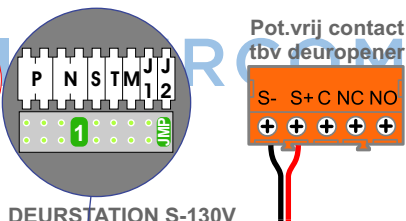
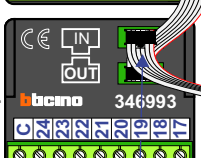

DEURSTATION S-130V

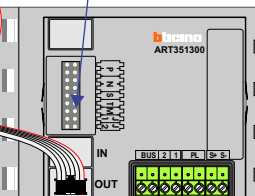

nokjes connectoren
 wijzen naar elkaar

Max. 50 meter

Max. 100 meter systeem-
 kabel tot laatste videofoon

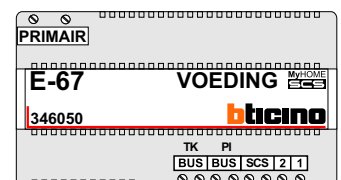

N-Waarde	Huisnummer	Switch-ON
1	1	X
2	1a	X
3	3	X
4	3a	X
5	3b	X
6	3c	X
7	5	X
8	5a	X
9	5b	X
10	5c	X
11	7	X
12	7a	X
13	7b	X
14	7c	X
15	9	X
16	9a	X
17	9b	X
18	9c	X



nelec
INTERCOM MADE EASY